

## BIONIQ ROUND ADJUSTABLE TRIMLESS

### A35179-

base number LED Dimming Color Temperature Finishes (Diamond) Ceiling Thickness Reflector Options

- To build a product code in our configurator select the specify button on the base model # product page
- To build a manual product code on this datasheet choose from the options listed below in blue font and add the suffix to the base model #

#### GENERAL

Series: Bioniq  
 Subseries: Bioniq Round Adjustable  
 Brand: Prolicht  
 Division: Architectural  
 Mounting Type: Trimless  
 Mounting Location: Ceiling  
 Subcategory: Downlight

#### PHYSICAL

Shape: Round  
 Diameter (mm): 107  
 Diameter (in): 4 3/16  
 Height (mm): 112  
 Height (in): 4 7/16  
 Ceiling Thickness (mm): 10 / 12.5 / 15 / 25  
 Ceiling Thickness (in): 3/8 or 1/2 or 9/16 or 1  
 Min. Recessing Depth (mm): 130  
 Min. Recessing Depth (in): 5 1/8  
 Light Distribution: Adjustable / Downlight  
 Weight (kg): 0.557  
 Weight (lbs): 1.227  
 Fixture Finish: SSR / BKV / CWI / CRY / HAB / LAG / UFT / ITA / RUA / RUR / MIC / FTG / MYG / TWT / LOD / PUS / FRO / FUP / KIA / POP / BLS / SPG / MEY / GOH / GUM / CHC / COM / ABZ / JAG / OBR / MOS / ROR  
 Fixture Material: Aluminum Die Cast  
 Cut-out Measurements: Ø 111mm / 4 3/8"  
 Upon Request: Unique Ceiling Thickness

#### ELECTRICAL

Lamp Type: LED (Zhaga Standard)  
 Input Wattage (W): 15.5  
 Total Output Wattage (W): 14.5  
 Dimming: Tri-Mode (Non-Dimming and Phase Dimming (120Vac only) and 0-10V Dimming)  
 Driver Included: No  
 Driver Location: Recessed Housing  
 Driver Type: Constant Current - Universal  
 Driver Class: Class 2  
 Housing: See components  
 Input Voltage (V): 120 - 277  
 Constant Current (MA): 500

#### LED

Number of LEDs: 1  
 Color Temperature (°K): 2700 / 3000 / 3500 / 4000  
 Max. Delivered Lumen (lm): 940 / 980 / 1029 / 1050  
 CRI: >90 CRI  
 Efficiency (%): 87.9 / 88.4 / 87.9 / 87.9  
 Lamp Life (hrs): 50000  
 Upon Request: RGB-W Tunable White Special Color Temperature Special LED

#### OPTICAL

Reflector: 20 / 40 / 60  
 Adjustability: Rotational 355°; Tilt 30°  
 Upon Request: Special Beam Angles

#### RATINGS AND CERTIFICATIONS

Certified By: Certified for North American Standards  
 Zaneen Group Inc. © 2024, T 1800-388-3382, F 416-247-9319, www.zaneen.com  
 IP Rating: IP20  
 Available for international specifications by adding "INT" at the end of the existing Model #. For assistance on 'custom' specifications, contact zteam@zaneen.com.  
 In a constant effort to supply the best product, we reserve the right to change specifications or materials without notice. The most recent specification sheets are found at zaneen.com



## BIONIQ ROUND ADJUSTABLE TRIMLESS

A35179-

PROJECT	_____
TYPE	_____
SPECIFIER	_____
QUANTITY	_____
DATE	_____



PROJECT	_____
TYPE	_____
SPECIFIER	_____
QUANTITY	_____
DATE	_____

## BIONIQ ROUND SEMI ADJUSTABLE TRIMLESS

### A35200-

base number	LED Dimming	Color Temperature	Finishes (Diamond)	Ceiling Thickness	Reflector Options
-------------	-------------	-------------------	--------------------	-------------------	-------------------

- To build a product code in our configurator select the specify button on the base model # product page
- To build a manual product code on this datasheet choose from the options listed below in blue font and add the suffix to the base model #

#### GENERAL

Series: Bioniq  
 Subseries: Bioniq Round Semi Adjustable  
 Brand: Prolicht  
 Division: Architectural  
 Mounting Type: Trimless  
 Mounting Location: Ceiling  
 Subcategory: Downlight

#### PHYSICAL

Shape: Round  
 Diameter (mm): 107  
 Diameter (in): 4 3/16  
 Height (mm): 112  
 Height (in): 4 7/16  
 Ceiling Thickness (mm): 10 / 12.5 / 15 / 25  
 Ceiling Thickness (in): 3/8 or 1/2 or 9/16 or 1  
 Min. Recessing Depth (mm): 130  
 Min. Recessing Depth (in): 5 1/8  
 Light Distribution: Adjustable / Downlight  
 Weight (kg): 0.621  
 Weight (lbs): 1.37  
 Fixture Finish: SSR / BKV / CWI / CRY / HAB / LAG / UFT / ITA / RUA / RUR / MIC / FTG / MYG / TWT / LOD / PUS / FRO / FUP / KIA / POP / BLS / SPG / MEY / GOH / GUM / CHC / COM / ABZ / JAG / OBR / MOS / ROR  
 Fixture Material: Aluminum Die Cast  
 Cut-out Measurements:  $\square$  111mm / 4 3/8"  
 Upon Request: Unique Ceiling Thickness

#### ELECTRICAL

Lamp Type: LED (Zhaga Standard)  
 Input Wattage (W): 15.5  
 Total Output Wattage (W): 14.5  
 Dimming: Tri-Mode (Non-Dimming and Phase Dimming (120Vac only) and 0-10V Dimming)  
 Driver Included: No  
 Driver Location: Recessed Housing  
 Driver Type: Constant Current - Universal  
 Driver Class: Class 2  
 Housing: See components  
 Input Voltage (V): 120 - 277  
 Constant Current (MA): 500

#### LED

Number of LEDs: 1  
 Color Temperature (°K): 2700 / 3000 / 3500 / 4000  
 Max. Delivered Lumen (lm): 940 / 980 / 1029 / 1050  
 Nominal Lumen (lm): 1386 / 1438 / 1511 / 1542  
 CRI: >90 CRI  
 Efficiency (%): 87.9 / 88.4 / 87.9  
 Lamp Life (hrs): 50000  
 Upon Request: RGB-W Tunable White Special Color Temperature Special LED

#### OPTICAL

Reflector: 20 / 40 / 60  
 Adjustability: Rotational 355°; Tilt 10°  
 Upon Request: Special Beam Angles

#### RATINGS AND CERTIFICATIONS

Zaneen Group Inc. © 2024, T 1800-388-3382, F 416-247-9319, www.zaneen.com  
 Certified By: Certified for North American Standards  
 Available for International specifications by adding "INT" at the end of the existing Model #. For assistance on 'custom' specifications, contact zteam@zaneen.com.  
 IP Rating: IP20  
 If a conflict occurs to supply the best product, we reserve the right to change specifications or materials without notice. The most recent specification sheets are found at zaneen.com



Ø 107mm 4 3/16"

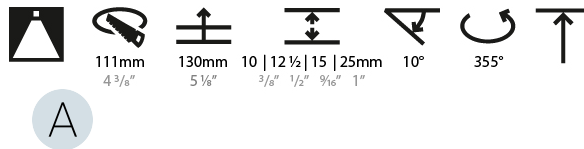

## BIONIQ ROUND SEMI ADJUSTABLE TRIMLESS

A35200-

PROJECT

TYPE

SPECIFIER

QUANTITY

DATE



PROJECT	
TYPE	
SPECIFIER	
QUANTITY	
DATE	

## BIONIQ ROUND ADJUSTABLE RECESSED

### A35227-

base number	Color Temperature	Finishes (Diamond)	Reflector Options	Lens Options
-------------	----------------------	-----------------------	----------------------	-----------------

- To build a product code in our configurator select the specify button on the base model # product page
- To build a manual product code on this datasheet choose from the options listed below in blue font and add the suffix to the base model #

#### GENERAL

Series: Bioniq
Subseries: Bioniq Round Adjustable
Brand: Prolicht
Division: Architectural
Mounting Type: Recessed
Mounting Location: Ceiling
Subcategory: Downlight

#### PHYSICAL

Shape: Round
Diameter (mm): 107
Diameter (in): 4 3/16
Height (mm): 112
Height (in): 4 7/16
Ceiling Thickness (mm): 10 / 12.5 / 15
Ceiling Thickness (in): 3/8 or 1/2 or 9/16
Min. Recessing Depth (mm): 130
Min. Recessing Depth (in): 5 1/8
Light Distribution: Adjustable / Downlight
Weight (kg): 0.46
Weight (lbs): 1.01
Fixture Finish: SSR / BKV / CWI / CRY / HAB / LAG / UFT / ITA / RUA / RUR / MIC / FTG / MYG / TWT / LOD / PUS / FRO / FUP / KIA / POP / BLS / SPG / MEY / GOH / GUM / CHC / COM / ABZ / JAG / OBR / MOS / ROR
Fixture Material: Aluminum Die Cast
Cut-out Measurements: 98mm / 3 7/8"

#### ELECTRICAL

Lamp Type: LED (Zhaga Standard)
Input Wattage (W): 16.5
Total Output Wattage (W): 14
Dimming: Tri-Mode (Non-Dimming and Phase Dimming (120Vac only) and 0-10V Dimming)
Driver Included: No
Driver Location: Recessed Housing
Driver Type: Constant Current - Universal
Driver Class: Class 2
Housing: See components
Input Voltage (V): 120 - 277
Constant Current (MA): 500

#### LED

Number of LEDs: 1
Color Temperature (°K): 2700 / 3000 / 3500 / 4000
Max. Delivered Lumen (lm): 930 / 960 / 1009 / 1030
Nominal Lumen (lm): 1386 / 1438 / 1511 / 1542
CRI: >90 CRI
Lamp Life (hrs): 50000

#### OPTICAL

Reflector°: 20 / 40 / 60
Adjustability: Rotational 355°; Tilt 30°

#### RATINGS AND CERTIFICATIONS

Certified By: Certified for North American Standards
IP rating: IP20

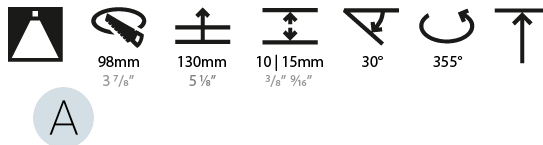

## BIONIQ ROUND ADJUSTABLE RECESSED

A35227-

PROJECT

TYPE

SPECIFIER

QUANTITY

DATE



PROJECT	_____
TYPE	_____
SPECIFIER	_____
QUANTITY	_____
DATE	_____

## BIONIQ ROUND SEMI ADJUSTABLE RECESSED

### A35293-

base number	Color	Finishes	Reflector
	Temperature	(Diamond)	Options

- To build a product code in our configurator select the specify button on the base model # product page
- To build a manual product code on this datasheet choose from the options listed below in blue font and add the suffix to the base model #

#### GENERAL

Series: Bioniq  
 Subseries: Bioniq Round Semi Adjustable  
 Brand: Prolicht  
 Division: Architectural  
 Mounting Type: Recessed  
 Mounting Location: Ceiling  
 Subcategory: Downlight

#### PHYSICAL

Shape: Round  
 Diameter (mm): 107  
 Diameter (in): 4 3/16  
 Height (mm): 112  
 Height (in): 4 7/16  
 Ceiling Thickness (mm): 10 / 12.5 / 15  
 Ceiling Thickness (in): 3/8 or 1/2 or 9/16  
 Min. Recessing Depth (mm): 130  
 Min. Recessing Depth (in): 5 1/8  
 Light Distribution: Adjustable / Downlight  
 Weight (kg): 0.485  
 Weight (lbs): 1.07  
 Fixture Finish: SSR / BKV / CWI / CRY / HAB / LAG / UFT / ITA / RUA / RUR / MIC / FTG / MYG / TWT / LOD / PUS / FRO / FUP / KIA / POP / BLS / SPG / MEY / GOH / GUM / CHC / COM / ABZ / JAG / OBR / MOS / ROR  
 Fixture Material: Aluminum Die Cast  
 Cut-out Measurements: 98mm / 3 7/8"

#### ELECTRICAL

Lamp Type: LED (Zhaga Standard)  
 Input Wattage (W): 15.5  
 Total Output Wattage (W): 13  
 Dimming: Tri-Mode (Non-Dimming and Phase Dimming (120Vac only) and 0-10V Dimming)  
 Driver Included: No  
 Driver Location: Recessed Housing  
 Driver Type: Constant Current - Universal  
 Driver Class: Class 2  
 Housing: See components  
 Input Voltage (V): 120 - 277  
 Constant Current (MA): 500

#### LED

Number of LEDs: 1  
 Color Temperature (°K): 2700 / 3000 / 3500 / 4000  
 Max. Delivered Lumen (lm): 940 / 980 / 1029 / 1050  
 Nominal Lumen (lm): 1386 / 1438 / 1511 / 1542  
 CRI: >90 CRI  
 Lamp Life (hrs): 50000

#### OPTICAL

Reflector: 20 / 40 / 60  
 Adjustability: Rotational 355°, Tilt 10°

#### RATINGS AND CERTIFICATIONS

Certified By: Certified for North American Standards  
 IP rating: IP20



## BIONIQ ROUND SEMI ADJUSTABLE RECESSED

A35293-

PROJECT

TYPE

SPECIFIER

QUANTITY

DATE





PROJECT	_____
TYPE	_____
SPECIFIER	_____
QUANTITY	_____
DATE	_____

## BIONIQ ROUND SEMI ADJUSTABLE RECESSED

### A35305-

base number	Color	Finishes	Reflector
	Temperature	(Diamond)	Options

- To build a product code in our configurator select the specify button on the base model # product page
- To build a manual product code on this datasheet choose from the options listed below in blue font and add the suffix to the base model #

#### GENERAL

Series: Bioniq  
 Subseries: Bioniq Round Semi Adjustable  
 Brand: Prolicht  
 Division: Architectural  
 Mounting Type: Recessed  
 Mounting Location: Ceiling  
 Subcategory: Downlight

#### PHYSICAL

Shape: Round  
 Diameter (mm): 107  
 Diameter (in): 4 3/16  
 Height (mm): 112  
 Height (in): 4 7/16  
 Ceiling Thickness (mm): 10 / 12.5 / 15  
 Ceiling Thickness (in): 3/8 or 1/2 or 9/16  
 Min. Recessing Depth (mm): 130  
 Min. Recessing Depth (in): 5 1/8  
 Light Distribution: Adjustable / Downlight  
 Weight (kg): 0.465  
 Weight (lbs): 1.03  
 Fixture Finish: SSR / BKV / CWI / CRY / HAB / LAG / UFT / ITA / RUA / RUR / MIC / FTG / MYG / TWT / LOD / PUS / FRO / FUP / KIA / POP / BLS / SPG / MEY / GOH / GUM / CHC / COM / ABZ / JAG / OBR / MOS / ROR  
 Fixture Material: Aluminum Die Cast  
 Cut-out Measurements: 98mm / 3 7/8"

#### ELECTRICAL

Lamp Type: LED (Zhaga Standard)  
 Input Wattage (W): 16.5  
 Total Output Wattage (W): 13  
 Dimming: Tri-Mode (Non-Dimming and Phase Dimming (120Vac only) and 0-10V Dimming)  
 Driver Included: No  
 Driver Location: Recessed Housing  
 Driver Type: Constant Current - Universal  
 Driver Class: Class 2  
 Housing: See components  
 Input Voltage (V): 120 - 277  
 Constant Current (MA): 500

#### LED

Number of LEDs: 1  
 Color Temperature (°K): 2700 / 3000 / 3500 / 4000  
 Max. Delivered Lumen (lm): 1130 / 1180 / 1235 / 1260  
 Nominal Lumen (lm): 1386 / 1438 / 1511 / 1542  
 CRI: >90 CRI  
 Lamp Life (hrs): 50000

#### OPTICAL

Reflector: 20 / 40 / 60  
 Adjustability: Rotational 355°, Tilt 10°

#### RATINGS AND CERTIFICATIONS

Certified By: Certified for North American Standards  
 IP rating: IP54

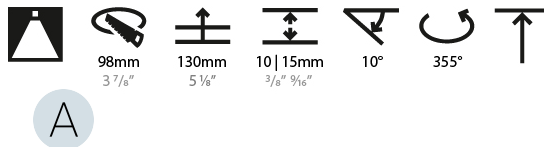

## BIONIQ ROUND SEMI ADJUSTABLE RECESSED

A35305-

PROJECT

TYPE

SPECIFIER

QUANTITY

DATE



A

## BIONIQ SQUARE PINHOLE RECESSED

**A35377-**

base number    Color    Finishes    Reflector  
 Temperature    (Diamond)    Options

PROJECT
TYPE
SPECIFIER
QUANTITY
DATE

- To build a product code in our configurator select the specify button on the base model # product page
- To build a manual product code on this datasheet choose from the options listed below in blue font and add the suffix to the base model #

### GENERAL

Series: Bioniq  
 Subseries: Bioniq Square Pinhole  
 Brand: Prolicht  
 Division: Architectural  
 Mounting Type: Recessed  
 Mounting Location: Ceiling  
 Subcategory: Downlight

### PHYSICAL

Shape: Square  
 Length (mm): 107  
 Length (in): 4 3/16  
 Width (mm): 107  
 Width (in): 4 3/16  
 Depth (mm): 112  
 Depth (in): 4 7/16  
 Ceiling Thickness (mm): 10 / 12.5 / 15  
 Ceiling Thickness (in): 3/8 or 1/2 or 9/16  
 Min. Recessing Depth (mm): 130  
 Min. Recessing Depth (in): 5 1/8  
 Light Distribution: Adjustable / Downlight  
 Weight (kg): 0.479  
 Weight (lbs): 1.06  
 Fixture Finish: SSR / BKV / CWI / CRY / HAB / LAG / UFT / ITA / RUA / RUR / MIC / FTG / MYG / TWT / LOD / PUS / FRO / FUP / KIA / POP / BLS / SPG / MEY / GOH / GUM / CHC / COM / ABZ / JAG / OBR / MOS / ROR  
 Fixture Material: Aluminum Die Cast  
 Cut-out Measurements: 98mm / 3 7/8"

### ELECTRICAL

Lamp Type: LED (Zhaga Standard)  
 Input Wattage (W): 16.5  
 Total Output Wattage (W): 14  
 Dimming: Tri-Mode (Non-Dimming and Phase Dimming (120Vac only) and 0-10V Dimming)  
 Driver Included: No  
 Driver Location: Recessed Housing  
 Driver Type: Constant Current - Universal  
 Driver Class: Class 2  
 Housing: See components  
 Input Voltage (V): 120 - 277  
 Constant Current (MA): 500

### LED

Number of LEDs: 1  
 Color Temperature (°K): 2700 / 3000 / 3500 / 4000  
 Max. Delivered Lumen (lm): 940 / 980 / 1029 / 1050  
 Nominal Lumen (lm): 1386 / 1438 / 1511 / 1542  
 CRI: >90 CRI  
 Lamp Life (hrs): 50000

### OPTICAL

Reflector°: 20 / 40 / 60  
 Adjustability: Rotational 355°; Tilt 30°

### RATINGS AND CERTIFICATIONS

Certified By: Certified for North American Standards  
 IP rating: IP20

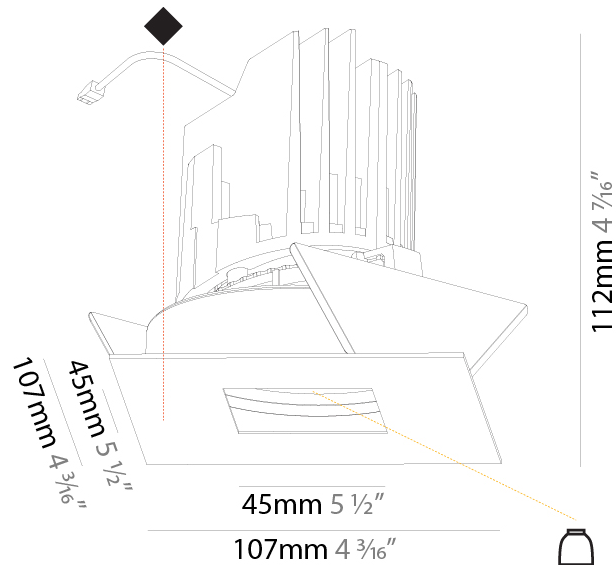

## BIONIQ SQUARE PINHOLE RECESSED

A35377-

PROJECT

TYPE

SPECIFIER

QUANTITY

DATE



A

PROJECT \_\_\_\_\_  
 TYPE \_\_\_\_\_  
 SPECIFIER \_\_\_\_\_  
 QUANTITY \_\_\_\_\_  
 DATE \_\_\_\_\_

**Fixture Finish**

Sparkling Silver - 01 (SSR)



Black Velvet - 02 (BKV)



Crystal White - 03 (CWI)



Creamy - 04 (CRY)



Hampton Bay - 05 (HAB)



Lagoon - 06 (LAG)



Urban Forest - 07 (UFT)



In the Army - 08 (ITA)



Rusty Angel - 09 (RUA)



Rusty Rush - 10 (RUR)



Milk and Chocolate - 11 (MIC)



Fade to Gray - 12 (FTG)



Mysterious Gray - 13 (MYG)



Twilight - 14 (TWT)



Lost Dream - 15 (LOD)



Purple Sky - 16 (PUS)



Fresh Oh - 17 (FRO)



Funky P. - 18 (FUP)



Kissing Aphrodite - 19 (KIA)



Poseidon's Paradise - 20 (POP)



Blue Sky - 21 (BLS)



Spring Green - 22 (SPG)



Mellow Yellow - 23 (MEY)



Golden Heart - 24 (GOH)



Gun Metal - 25 (GUM)



Champagne Cream - 26 (CHC)



Copper Mine - 27 (COM)



Ancient Bronze - 28 (ABZ)



Jazz Gold - 29 (JAG)



Olive Breeze - 30 (OBR)



Moonlight Silver - 31 (MOS)



Rosewood Red - 32 (ROR)



**Digital:** Not all screens are calibrated the same, and therefore, colors will appear differently between devices.  
**Physical:** When texture is involved, there will be variations in color, character and tone within a product and between product families.



**Gun Metal:** No Gun Metal finish is alike. It combines a mixture of transparent and black color particles to ensure a highly individual effect and no luminaire being identical.  
**Champagne Cream, Copper Mine, Ancient Bronze & Jazz Gold:** These finishes have slight fading from specific powder coating production. Each luminaire will slightly vary.

PROJECT	
TYPE	
SPECIFIER	
QUANTITY	
DATE	











### LEGEND

	floor-mounted		pivotal		special LED (upon request) RGB, RGBW, tunable, gold+, meat+, art+, fashion+
	wall and ceiling: recessed and surface mounted		rotating		warm dim / natural dimming LED
	ceiling-mounted and wall-mounted		illuminate tilted		rechargeable battery powered
	wall-mounted		color of suspension cable		fixture with natural vivid LED (upon request)
	omni-directional light distribution		length of suspension cable		color rendering index
	direct light distribution		reflector degree selection		color temperature
	direct/indirect light distribution		super spot		lumen (luminous flux)
	indirect light distribution		lens		efficacy (lumens per watt)
	asymmetric light distribution		lens pack		Unified Glare Rating (UGR) range from 5-40
	aura light distribution		shine ring		marine grade (AISI 316 stainless steel)
	round wall or ceiling cut-out		integrated shine ring with diffuser		walk on
	square wall or ceiling cut-out		free individual colors 01-29		drive on
	the supplied jig specifies the cutout dimensions		individual colors: 00 (free of charge), 01-25 (extra charge)		Dark Sky Compliance
	minimum distance (meters) lamp - object		luminaire part to be colored (F1)		Americans with Disabilities Act (less than 4" off the wall located between 27"-84" from floor)
	recessed depth		luminaire part to be colored (F2)		lamp protected against explosion
	ceiling thickness in mm		luminaire part to be colored (F3)		blown glass using traditional methods by master glass blower
	ceiling thickness selection		luminaire part to be colored (F4)		acoustic material
	dimnable DP (phase), DV (0-10V), DD (dali), DS (step-dim)		luminaire part to be colored (F5)		protection class I, protection insulation
	included or excluded LED driver/transformer/control gear		color of 3-circuit adaptor		protection class II, protection insulation
	separately switchable		indirect diffuser		ETL Certified to UL and CSA Standards
	sensor		direct diffuser		UL Certified to UL and CSA Standards
	remote control		ball-proof (upon request)		CSA Certified to UL and CSA Standards
	available upon request		accessory		Certified for North American Standards

### IP RATING

	protected against ingress of solid bodies greater than 12.5mm (finger)
	protected against ingress of solid bodies greater than 2.5mm protected against sprays of water up to 60 degrees from the vertical (rain)
	protected against ingress of solid bodies greater than 1mm (wire) no protection against the ingress of moisture
	protected against ingress of solid bodies greater than 1mm (wire) protected against sprays of water up to 60 degrees from the vertical (rain)
	protected against ingress of solid bodies greater than 1mm (wire) protected against water splashed from all directions
	protected against limited ingress of dust (wet rooms/covered outdoor areas) protected against water splashed from all directions
	protected against ingress of dust protected against jets of water
	protected against ingress of dust protected against powerful jets of water or heavy seas
	protected against ingress of dust protected against immersion of water between 15cm - 1m for 30 minutes
	protected against ingress of dust protected against immersion of water under pressure for long periods

### IK RATING

	protected against 0.14 joules impact (equivalent to 0.25kg mass dropped from 56mm above the surface)
	protected against 0.2 joules impact (equivalent to 0.25kg mass dropped from 80mm above the surface)
	protected against 0.35 joules impact (equivalent to 0.25kg mass dropped from 140mm above the surface)
	protected against 0.5 joules impact (equivalent to 0.25kg mass dropped from 200mm above the surface)
	protected against 0.7 joules impact (equivalent to 0.25kg mass dropped from 280mm above the surface)
	protected against 1 joules impact (equivalent to 0.25kg mass dropped from 400mm above the surface)
	protected against 2 joules impact (equivalent to 0.5kg mass dropped from 400mm above the surface)
	protected against 5 joules impact (equivalent to 1.7kg mass dropped from 300mm above the surface)
	protected against 10 joules impact (equivalent to 5.0kg mass dropped from 200mm above the surface)
	protected against 20 joules impact (equivalent to 5.0kg mass dropped from 400mm above the surface)